

THE BPM DAQ SYSTEM UPGRADE FOR SUPERKEKB INJECTOR LINAC

M. Satoh[#], F. Miyahara, T. Suwada, and K. Furukawa, Accelerator Laboratory, High Energy Accelerator Research Organization (KEK), 1-1 Oho, Tsukuba, Ibaraki 305-0801, Japan

T. Kudou and S. Kusano, Mitsubishi Electric System & Service Co., Ltd, 2-8-8 Umezono, Tsukuba, Ibaraki 305-0045, Japan

Abstract

The KEK electron/positron linac is a 600-m-long injector that provides the beams with different energy to four independent storage rings. The non-destructive beam position monitor (BPM) is an indispensable diagnostic tool for a long-term stable beam operation. In the KEK linac, about one hundred BPMs with the four strip-line type electrodes are utilized for the beam orbit and charge measurement. The measured beam orbit data is used for the beam orbit and energy feedback loops. The current data acquisition (DAQ) system for BPM comprises 24 fast digital oscilloscopes. They can work as a WindowsXP-based EPICS IOC.

Toward the SuperKEKB project, the upgrade of injector linac is going on for increasing the beam intensity and reducing the emittance. For the SuperKEKB injector linac, the electron beam emittance will be reduced one-fifth smaller than that of former KEKB project by using a new RF gun. For this reason, the measurement precision of BPM is strongly required to be increased. In this paper, we present the upgrade plan and status of DAQ system for BPM towards SuperKEKB project in detail.

INTRODUCTION

The KEK linac sequentially provides the electron and positron beams with different energies and intensities for four independent storage rings as shown in Table 1. For increasing the integrated luminosity and stored current stability, the simultaneous injection between KEKB electron and positron rings has been strongly required. In addition, the PF top-up injection has been also strongly demanded even during the KEKB injection. For these reasons, the injector upgrade project started in 2004 so that the simultaneous top-up of KEKB electron/positron and PF rings. This upgrade was completed in April 2009, and the simultaneous top-up injection among three independent rings was successfully achieved [1, 2, 3, 4].

Whereas the KEKB project has completed in the summer of 2010, the Super KEKB project has started for aiming at the peak luminosity of 40 times higher than that of former KEKB project. For this purpose, the injector linac upgrade is going on for increasing the beam intensity and reducing the emittance. In this linac upgrade, main issues are the construction of positron damping ring, the development of the new positron capture system for increasing the positron charge of four times present, and

the installation of a low emittance electron gun as shown in Fig. 1. The performance required of beam position measurement is a higher precision of ten micro meters or less since the emittance of electron and positron beams are less than 20 mm-mrad.

Table 1: Injection beam energy and charge for each ring

	KEKB e- /SuperKEKB e-	KEKB e+/SuperKEKB e+	PF	PF- AR
Injection beam energy (GeV)	8/7	3.5/4	2.5	3
Beam charge /bunch (nC)	1/5	1 (10 [*])/4(10 [*])	0.1	0.1

*Charge of primary electron for positron production

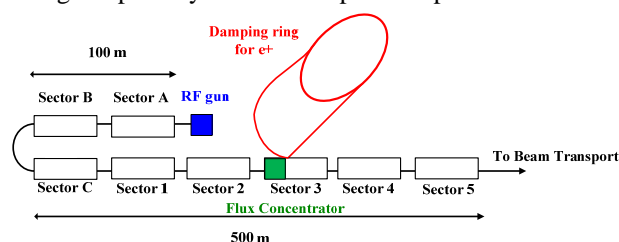

Figure 1: Schematics drawing of SuperKEKB injector linac. The coloured parts will be newly installed for SuperKEKB project.

LOW EMITTANCE ELECTRON BEAM DELIVERY

For the SuperKEKB project, the emittance of positron beam will be reduced 10 mm-mrad from 2100 mm-mrad by using the damping ring newly constructed. The

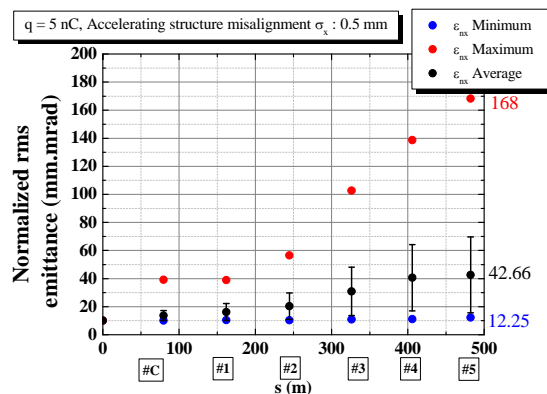

Figure 2: Simulation result of horizontal emittance growth in the KEK injector linac from Sector C to Sector 5.

[#] masanori.satoh@kek.jp

emittance of electron beam will be reduced 20 mm-mrad from 100 by a low emittance rf gun. The low emittance electron beam should be delivered to the ring without damping ring due to cost reduction. In the high intensity electron linacs, emittance growth can be caused by the misalignment of accelerating structures and magnets.

Figure 2 shows the simulation result of horizontal emittance growth in the KEK linac. Here, it is assumed that the KEK injector linac configuration from Sector C to Sector 5, bunch charge of 5 nC and initial normalized rms emittance of 10 mm-mrad, and the accelerating structure misalignment of 0.5 mm with standard deviation. In this simulation, the emittance calculations were carried out by using simulation code elegant and 100 different error seeds. The simulation result shows that the average and maximum emittances at the end of Sector 5 are 42.66 mm-mrad and 168 mm-mrad, respectively. The final emittance strongly depends on the seeds of error.

On the other hand, the fine control of beam orbit can cure the emittance deterioration. Figure 3 shows the simulation result of emittance growth compensation by using the fine control of initial beam offset and angle. In this simulation, we used the seed of alignment error corresponding to the maximum emittance growth of 168 mm-mrad. The simulation result shows that the final emittance can be reduced 11.5 mm-mrad from 168 mm-mrad by adjusting of initial beam angle and offset. The control values of initial beam angle and offset are 100 μ rad and 10 μ m, respectively. From these simulation results, the high precision beam position measurement is strongly required for the fine beam orbit control of SuperKEKB injector linac.

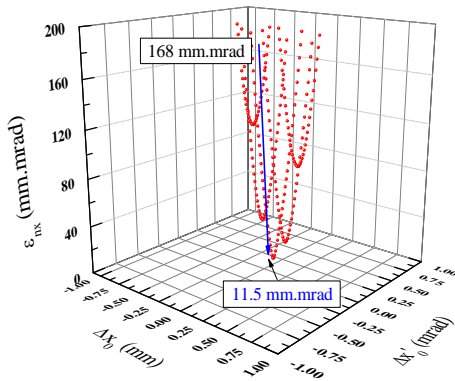

Figure 3: Simulation result of emittance growth compensation by using beam orbit control.

BPM DAQ SYSTEM,

Present System

In the KEK linac, many kinds of feedback loops have been developed and utilized to stabilize the beam orbit,

energy, and energy spread [5, 6, 7]. These feedback loops make use of the beam position information acquired by the non-destructive BPMs [8]. About one hundred stripline-type BPMs have been installed in the KEK linac.

The twenty four front-end systems have been installed in the linac klystron gallery at a nearly equal interval along the beam line. The each DAQ system deals with the analogue signals of 3 to 6 BPMs. A schematic drawing the present DAQ system is shown in Fig. 4. It comprises a fast digital oscilloscope (Tektronix DPO7104; 10 GSa/s, 4 channels, 8 bits, CPU P4/3.4 GHz, Gigabit-Ethernet) and a cable combiner box.

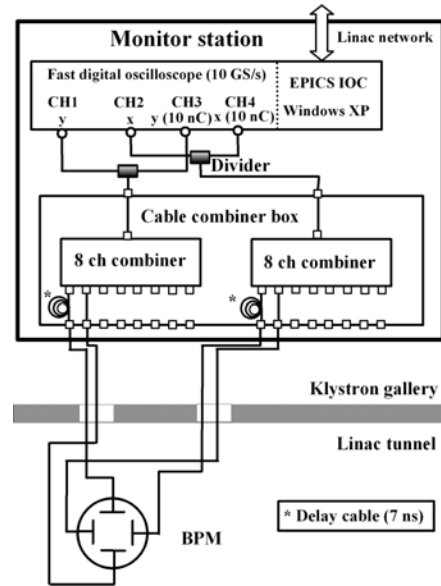

Figure 4: Schematic drawing of the present BPM DAQ system.

The four signals coming from one BPM are fed to two signal combiners (vertical and horizontal) together with the signals from other BPMs. The delay cables corresponding to a 7 ns time delay are used to avoid waveform overlaps at the signal combiners. The each output of combiner box is divided again into two signals. Since it is impossible to change the vertical scale of oscilloscope in every 50 Hz, CH1/CH2 and CH3/CH4 are used for the low charge and the high charge modes, respectively. The waveforms digitized at a sampling rate of 10 GSa/s are analyzed and converted into the beam parameters (beam charge, horizontal position, vertical position), taking into account the calibration coefficients. The DAQ software has been developed by using Microsoft Visual Studio 2005 C++, TekVisa, and EPICS R3.14.8.2 libraries. The DAQ software is running on the fast oscilloscope, and each DAQ can work as an EPICS IOC [9]. The similar DAQ system is also utilized for the KEKB and PF-AR beam transport lines [10].

The beam position measurement precision of the present system is listed in Table 2. These figures show the experimental results measured by three BPMs method [5]. The result of 1 nC shows worse precision than that of 0.1

nC since the same vertical scale settings are used for the measurements of 1 nC and 7 nC. There, the maximum ADC counts of 1 nC are smaller than the case of test with 0.1 nC electron. From these experimental results, it is difficult for the present DAQ system to achieve the beam position measurement precision of 10 μm or better. Toward Super KEKB linac, a new BPM DAQ system should be implemented since the ADC resolution of 8 bits limits the position measurement precision in the present system.

Table 2: BPM precision of the present DAQ system

Beam charge (nC)	Measurement precision (mm)
0.1	0.06626
1	0.10645
7	0.05052

New System

For the new DAQ system, the measurement precision of about 10 μm or better is one of key requirement. In addition, all beam position should be measured in every 20 ms interval. The SuperKEKB injector linac should perform the simultaneous injection to four independent rings since the beam lifetime of SuperKEKB is much shorter than that of KEKB rings. In the current design, it is estimated to be around 10 minutes. Figure 5 shows the beam operation scheme of SuperKEKB injector linac. The electron/positron beams with different energies and amounts of charges are delivered in every 20 ms. For this reason, the fast and precise attenuation control is also key requirement for the new system.

We adopt Libera Brilliance Single Pass unit as a

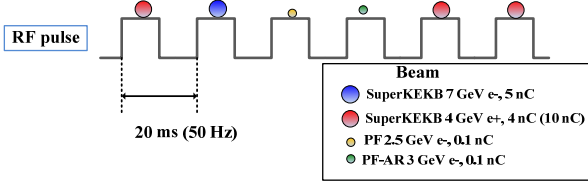

Figure 5: Schematics drawing of SuperKEKB injector linac beam operation. The beams with four different energies and amounts of charges should be managed.

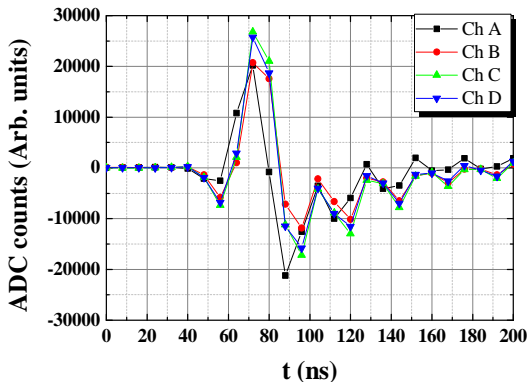

Figure 6: Raw waveform data measured by LIBERA Brilliance Single Pass unit.

candidate of the new system [11]. It is a commercial product of Instrumentation Technologies. It is a module dedicated for BPM DAQ and widely used at many recent accelerator facilities. Libera Brilliance Single Pass unit comprises four 16-bits ADCs of 125 MHz sampling frequency, two pass band saw filters in each analogue channel, a single-board computer (SBC), a field-programmable gate array (FPGA), and so on. It has also the variable attenuator with maximum attenuation of 31 dB. The attenuation level can be adjusted in 1 dB step.

The typical analogue signal shape from BPM electrode is a bipolar of 3 ns in width. Applying double saw filters, the signal is stretched to around 100 ns as shown in Fig. 6. After about 10 data points are sampled, the sum of squares of them is used as signal amplitude from each electrode. The data processing of digitized waveform is carried out on the FPGA side. The calculated beam position and other data are transferred to SBC side which is the embedded Linux operation system with fast Gigabit Ethernet. A client software like beam orbit display can retrieve the information of beam position and amount of charge via EPICS CA protocol.

EVALUATION OF DAQ PERFORMANCE

We evaluate the basic performance of Libera Brilliance Single Pass unit. Figure 7 shows the result of data acquisition defect by using test pulse of 50 Hz while four hours of continuous measurement. In this graph, the timestamp intervals between previous and current acquisitions are plotted as a function of test pulse number. From this result, all beam pulse can be measured up to 50 Hz since all timestamp differences are less than 40 ms. The more long-term experiment will be also carried out soon.

Figure 8 shows the precision of beam position measurement by using 1000 successive pulses of 0.1 nC electron beam. In this experiment, we used the eleven different steering settings and three LIBERAs connected to different BPMs. These results include the beam position fluctuation. The result of vertical direction at steering setting #5 of BPM#1 shows the standard deviation of 15 mm. The measurement precision of

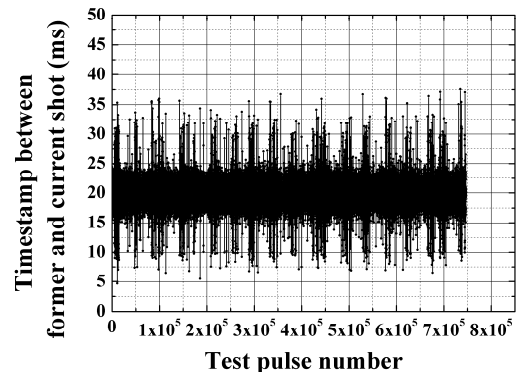

Figure 7: Result of data acquisition defect by using test pulse of 50 Hz while four hours of continuous test.

LIBERA Single Pass unit could be less than 15 mm when the effect of beam fluctuation is subtracted from this result. From these results, it is convinced that LIBERA Single Pass unit is feasible for our purpose.

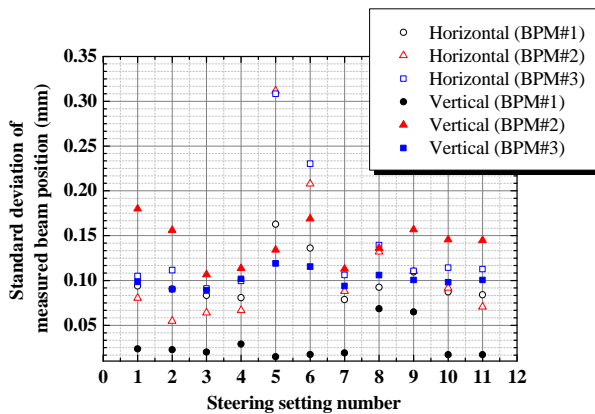

Figure 8: Precision of position measurement by using 0.1 nC beam and eleven different steering settings.

SUMMARY AND FUTURE PLAN

Toward the SuperKEKB project, the injector linac upgrade is going on for increasing the beam intensity and reducing the beam emittance. For the low emittance electron beam transport without damping ring, high precision beam position measurement and control are strongly required. For this purpose, the current BPM DAQ system should be replaced by new one with higher measurement precision. Recently, we preliminary evaluate the performance of a candidate Libera Brilliance Single Pass unit of Instrumentation Technologies.

In this performance test, we measured the speed performance of BPM signal detection and the precision of beam position measurement by using the KEK linac beam of 0.1 nC. The test result shows the speed performance is enough high for our application of 50 Hz beam measurement. The possibility of position measurement precision less than about 15 μm is also confirmed by the beam test.

The functionality of fast and precise attenuation control will be implemented soon. The complete test of position measurement precision by three BPMs method will also be carried out by using the KEK linac beam in the near future. At the same time, other schemes for getting the higher precision are also under consideration.

ACKNOWLEDGMENTS

The authors would like to thank Dr. Rok Hrovatin, Mr. Matjaz Znidarcic, Mr. Peter Leban of Instrumentation Technologies for their fruitful discussions.

REFERENCES

- [1] M. Satoh et al., "FIRST SIMULTANEOUS TOP-UP OPERATION OF THREE DIFFERENT RINGS IN KEK INJECTOR LINAC", in Proceedings of Linear Accelerator Conference LINAC2010, Tsukuba, Japan, pp.703-707 (2010).
- [2] K. Furukawa, M. Satoh, T. Suwada, T. T. Nakamura, T. Kudou, S. Kusano, T. Nakamura, A. Kazakov, "NEW EVENT-BASED CONTROL SYSTEM FOR SIMULTANEOUS TOP-UP OPERATION AT KEKB AND PF", in Proceedings of ICALEPCS2009, Kobe, Japan, pp.765-767 (2009).
- [3] Y. Ohnishi, T. Kamitani, N. Iida, M. Kikuchi, K. Furukawa, M. Satoh, K. Yokoyama, and Y. Ogawa, "Design and Performance of Optics for Multi-energy Injector Linac", in Proceedings of XXIV Linear Accelerator Conference, Victoria, British Columbia, Canada, Sep. 29–Oct. 3, pp.413-415 (2008).
- [4] N. Iida, K. Furukawa, M. Ikeda, T. Kamitani, M. Kikuchi, E. Kikutani, M. Kobayashi, T. Mimashi, T. Mitsuhashi, T. Miura, Y. Ogawa, Y. Ohnishi, S. Ohsawa, M. Satoh, M. Suetake, T. Suwada, M. Tawada, A. Ueda, Y. Yano, K. Yokoyama, and M. Yoshida, "PULSE-TO-PULSE SWITCHING INJECTION TO THREE RINGS OF DIFFERENT ENERGIES FROM A SINGLE ELECTRON LINAC AT KEK", in Proceedings of the Particle Accelerator Conference, Vancouver, Canada, May 4–8, pp.2769-2771 (2009).
- [5] T. Suwada, M. Satoh, and K. Furukawa, "Nondestructive beam energy-spread monitor using multi-strip-line electrodes", Phys. Rev. ST Accel. Beams 6, 032801 (2003).
- [6] T. Suwada, M. Satoh, and K. Furukawa, "New energy-spread-feedback control system using nondestructive energy-spread monitors", Phys. Rev. ST Accel. Beams 8, 112802 (2005).
- [7] K. Furukawa et al., "Beam Feedback Systems and BPM Read-Out System for the Two-Bunch Acceleration at the KEKB Linac", in Proceedings of the ICALEPCS2001, San Jose, November 2001, pp.266-268 (2001).
- [8] T. Suwada, N. Kamikubota, H. Fukuma, N. Akasaka, and H. Kobayashi, "Stripline-type beam-position-monitor system for single-bunch electron/positron beams", Nuclear Instruments and Methods in Physics Research A 440, pp.307-319 (2000).
- [9] M. Satoh, T. Suwada, K. Furukawa, Y. Hu, T. Kudou, S. Kusano, "EPICS IOC OF WINDOWSXP-BASED OSCILLOSCOPE FOR FAST BPM DATA ACQUISITION SYSTEM", in Proceedings of ICALEPCS2009, Kobe, Japan, pp.567-569 (2009).
- [10] T. Aoyama, T. Nakamura, K. Yoshii, N. Iida, M. Satoh, and K. Furukawa, "UPGRADE OF READOUT SYSTEM FOR BEAM POSITION MONITORS IN THE KEKB BEAM TRANSPORT LINE", in Proceedings of ICALEPCS2009, Kobe, Japan, pp.495-497 (2009).
- [11] <http://www.i-tech.si/>